



## Installation and Maintenance Instructions for GC55 Differential Pressure Transducer



Version 1.0 10/07

---

EDISON



## **WARNING! READ BEFORE INSTALLATION**

### **1. GENERAL:**

A failure resulting in **injury** or **damage** may be caused by excessive overpressure, excessive vibration or pressure pulsation, excessive instrument temperature, corrosion of the pressure containing parts, or other misuse. Consult Ashcroft Inc., Stratford, Connecticut, USA before installing if there are any questions or concerns.

### **2. OVERPRESSURE:**

Pressure spikes in excess of the rated overpressure capability of the transducer may cause **irreversible electrical and/or mechanical damage** to the pressure measuring and containing elements.

**Fluid hammer** and surges can destroy any pressure transducer and must always be avoided. A pressure snubber should be installed to eliminate the damaging hammer effects. Fluid hammer occurs when a liquid flow is suddenly stopped, as with quick closing solenoid valves. Surges occur when flow is suddenly begun, as when a pump is turned on at full power or a valve is quickly opened.

**Liquid surges** are particularly damaging to pressure transducers if the pipe is originally empty. To avoid damaging surges, fluid lines should remain full (if possible), pumps should be brought up to power slowly, and valves opened slowly. To avoid damage from both fluid hammer and surges, a surge chamber should be installed.

Symptoms of fluid hammer and surge's damaging effects:

- Pressure transducer exhibits an output at zero pressure (large zero offset).
- Pressure transducer output remains constant regardless of pressure
- In severe cases, there will be no output.

### **FREEZING:**

Prohibit freezing of media in pressure port. Unit should be drained (mount in vertical position with electrical termination upward) to prevent possible over-pressure damage from frozen media.

### **3. STATIC ELECTRICAL CHARGES:**

Any electrical device may be susceptible to damage when exposed to static electrical charges. To avoid damage to the transducer observe the following:

- Ground the body of the transducer **BEFORE** making any electrical connections.
- When disconnecting, remove the ground **LAST!**

---

Note: The shield and drain wire in the cable (if supplied) is not connected to the transducer body, and is not a suitable ground.

#### **4. USE IN LIFE SUPPORT DEVICES**

Ashcroft Inc. products are not authorized for use as critical components in life support devices or systems without the express written approval of the General Manager, Stratford Operations of Ashcroft Inc. As used herein:

1. Life support devices or systems are devices or systems which, (a) are intended for surgical implant into the body, or (b) support or sustain life, and whose failure to perform, when properly used in accordance with instructions for use provided in the labeling, can be reasonably expected to result in a significant injury to the user.
2. A critical component is any component of a life support device or system whose failure to perform can be reasonably expected to cause the failure of the life support device or system, or to affect its safety or effectiveness.

---

## CONTENTS

1. Specifications .....	6
2. Dimension Drawings .....	7-8
3. Installation .....	8
4. Wiring .....	9
5. Noise Prevention .....	9
6. Storage .....	9
7. Maintenance .....	9
8. Menu Navigation .....	11
9. Function Setting Mode .....	12
10. Switch Setting Mode .....	15
11. Switch Operation .....	17
12. Loop Check Mode .....	18
13. Other Functions .....	19
14. Maintenance & Warranty .....	22

---

## 1. Specifications

**Pressure Range:** 75, 100, 150, 250, 300 psid  
(as noted on the unit)

**Proof Pressure:** 2X F.S.

**Differential Pressure range ( $\Delta P$ ):**  $\Delta P = P1(H) - P2(L)$ ; as marked on unit

**Display Range:** Diff. pressure range of  $-5$  to  $105\%$  F.S. or display of  $-1999$  to  $1999$

**Power Supply:**

- 4-20ma Output Version: 15-27 Vdc, 80mA
- 1-5 Vdc Output Version: 11-27 Vdc, 60mA

**Display:**  $3\frac{1}{2}$  digit LED (digit height: 10mm)

Display accuracy

$\Delta P$  :  $\pm(1.0\%$  F.S.+1 digit)

P1, P2 :  $\pm(0.5\%$  F.S.+1 digit)

**Update Time:** 0.2 s

**Media / Wetted Materials:** Fluids and gases compatible with 304SS (sensor housing) and 17-4ph SS (sensor diaphragm)

**Output:**

**Analog Output (4-20mA or 1-5Vdc)\*:**

Accuracy:  $\pm 0.5\%$  FS (Accuracy includes the effects of Linearity, Hysteresis and Repeatability)

Temperature characteristics

$\Delta P$  : Zero  $\pm 0.1\%$  F.S./ $^{\circ}C$

: Span  $\pm 0.1\%$  F.S./ $^{\circ}C$

P1, P2 : Zero  $\pm 0.05\%$  F.S./ $^{\circ}C$

: Span  $\pm 0.05\%$  F.S./ $^{\circ}C$

Response Time: 20msec – 10.0 sec (by user)

Output Resolution: 0.2% FS

**Pressure Switch Output:**

Type: (2) photo MOS relays, rated to 40Vdc/200mA

Setting Accuracy:  $\pm 1.0\%$  FS

Number of Contacts: 2

Hysteresis/Deadband: Variable (by user)

Window Comparator: 1% F.S. fixed

Delay: 0-2.00s (both ON, OFF)

**Load resistance:** 10k $\Omega$  min-500 $\Omega$  max.

**Operating Temperature:**  $-10$  to  $50^{\circ}C$  (14 to  $122^{\circ}F$ )

**Operating humidity range:**

10 to 85%(with no condensation)

**Storage Temperature:**

-20 to 60°C (-4 to 140°F) (non freezing)

**Case construction:** IP65/NEMA 4

**Pressure Connections:** 1/8 NPT Female (2) places

**Enclosure Material:** Aluminum

**Weight:** 18 ounces

\*Option selected at time of order.

**2. Dimension Drawings**

Dimension In inches

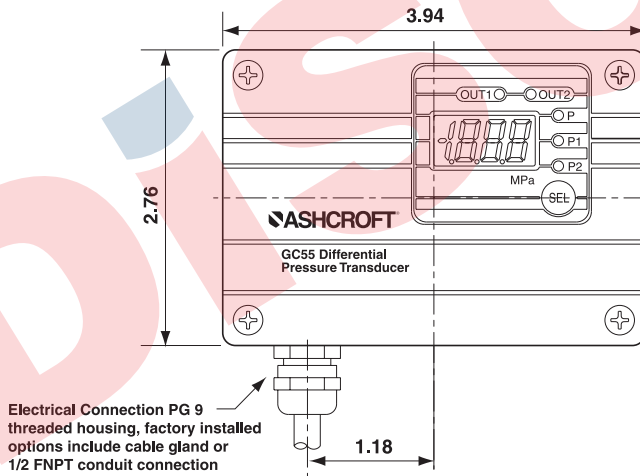

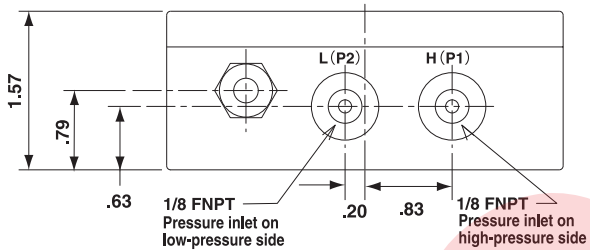

### 3. Installation

Install in a location where vibration and shock can be minimized and without direct sunlight on the display in compliance with IP64 environmental rating.

- Pressure Port Connections: 1/8 NPT female, 1 1/2 turns past hand tight.
- Mounting: Remove the GC55 cover, 4 screws, and attach via through holes, (2) places, 0.20" diameter.

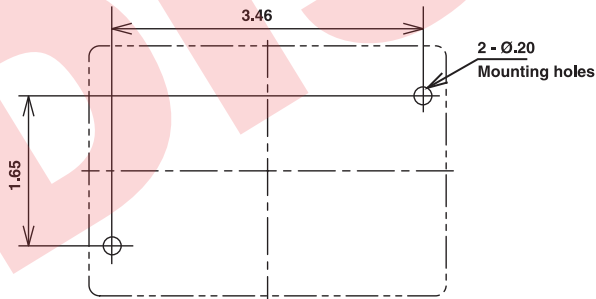

**Note:**  
(2) Mounting holes through  
back of enclosure, accessible  
with cover removed.



## 4. Wiring

### Terminal Strip Designations

The terminals are as shown below. Connect power only after checking wiring. After power is turned on, wait at least 15 minutes before performing a zero adjustment or measurement.

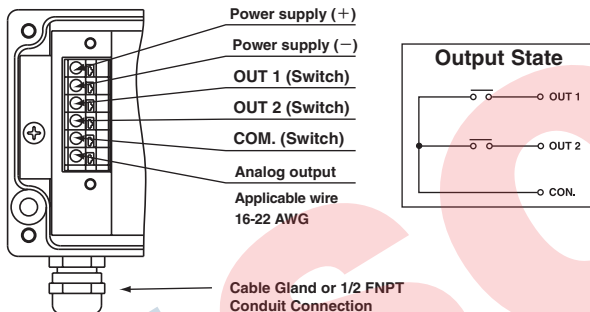

## 5. Noise Prevention

### Power Supply

If noise is present in the power supply / wires the pressure display can fluctuate and provide incorrect output. Care should be taken to keep the GC55 power supply wires from high voltage lines and use a power line with a high noise rejection ratio.

## 6. Storage

Store in a location in compliance with the environmental rating of the unit and within  $-20$  to  $+60\text{C}$  ( $-4$  to  $140\text{F}$ ). Avoid direct exposure of the display to sunlight

## 7. Maintenance

Although this is a solid state device a twice yearly visual inspection is recommended along with regular zero adjustment if necessary.

## 8. Menu Navigation

### Functions

PLEASE NOTE: Only the "SEL" function is available from the case exterior, access to all other functions requires the cover to be removed. Do not use sharp objects to press the keys as this can puncture the panel. See illustration 1 and illustration 2.

External Panel and Functions (SEL key can be operated externally)

Illustration (1)



Illustration (2)



## 8. Menu Navigation (cont.)

External Panel and Functions (SEL key can be operated externally)

Illustration (3)

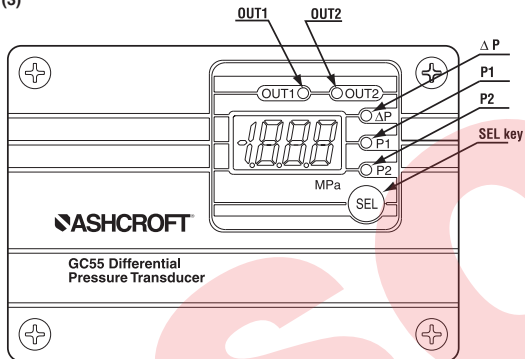

## 8. Menu Navigation (cont.)

Internal Panel and Functions (cover removed)

Illustration (4)

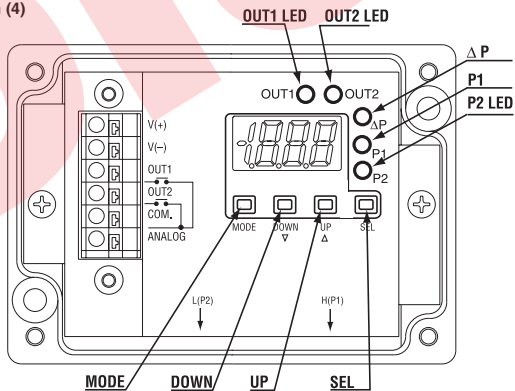



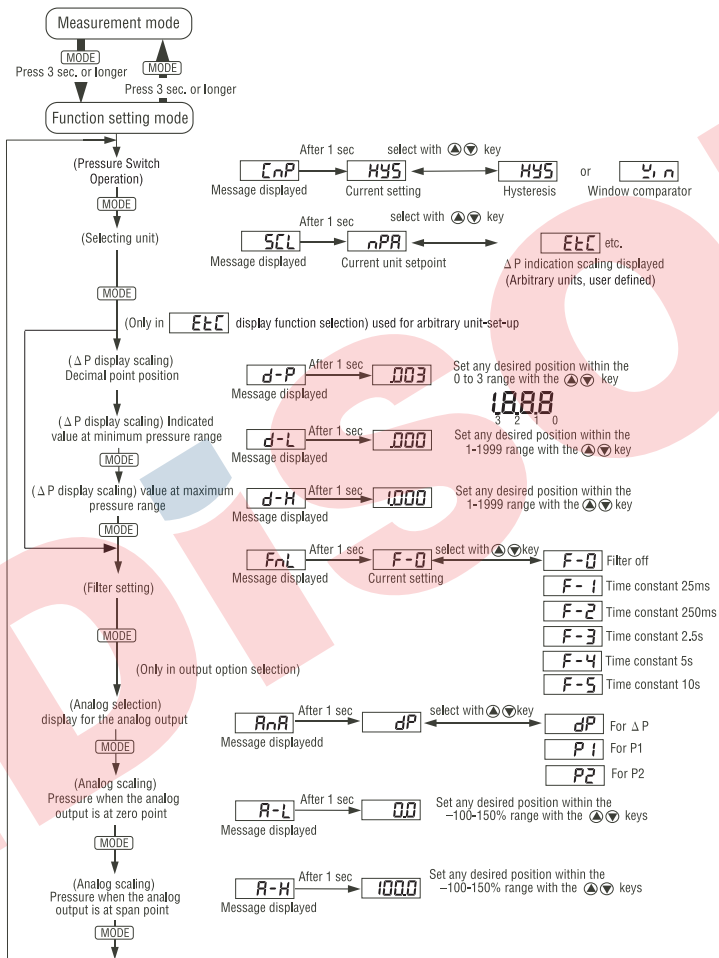

Entering the setting value in function setting mode resets all of the setting values including the switch. Please note that when the reset setting values are out of the display range, they will be adjusted to an upper or lower limit value that can be processed internally.

### Switch Operation

Select "Switch Operation Selection" with the **(MODE)** key. The message **[E n P]** is displayed for 1 sec. and then the current setting is displayed. Select either hysteresis or switch operation display with the **▲▼** keys.

### Display Section

Select "Display Selection" with the **(MODE)** key. The message **[5 E L]** displayed for 1 sec. and then the current setting is displayed. Select pressure display by PSI **[n P P]** or display scaling (Arbitrary units defined by user) **[E E E]** with the keys.

### Scaling Display of $\Delta P$ (Used for arbitrary unit, user defined, scaling)

When the **[E E E]** is selected in "Display Selection", the display value of  $\Delta P$  for applied pressure displays as an arbitrary scaling display. This is a function to scale the min/max display value for  $\Delta P$  display and has no effect on applied pressure and analog output.

Select "Display Scaling of  $\Delta P$ " with the **(MODE)** key. The message **[d - P]** is displayed for 1 sec. and then the current setting mode's decimal point position is displayed. Change the decimal point position value with the **▲▼** keys.

The pressure range min/max value can be set in the same way using the **(MODE)** and **▲▼** keys. The pressure range min/max display values are stored internally as operation coefficients. When "Display Scaling" **[E E E]** is selected, these coefficients are used for scaling and LED display.

Ex.) With a pressure range of 0 to 150 psid (0 to 100% F.S.), main unit display of 000.0 to 150.0 (factory set) is changed to a display of 0.000 to 1.000. (User defined unit, in this case 1MPa)

<b>[d - P]</b>	Dec. point position (from least significant digit):	0.1 → .003
<b>[d - L]</b>	Min. pressure range value:	0.0 → .000
<b>[d - H]</b>	Max. pressure range value:	150.0 → 1.000

### Filter Section

The GC55 is equipped with 5 internal time constant filters. Use this function when pressure fluctuations can result in erratic, difficult to read displays. The time constant for the selected filters reflects on the switch outputs as well as the analog output.

Select "Filter Selection" with the **MODE** key. The message **[F IL]** is displayed for 1 sec. and then the current setting mode's decimal point position is displayed. Change the decimal point position value with the **▲▼** keys.

Entering the setting value in function setting mode resets all of the setting

<b>F-0</b>	-----	No filter
<b>F-1</b>	-----	Time constant 25ms
<b>F-2</b>	-----	Time constant 250ms
<b>F-3</b>	-----	Time constant 2.5 sec
<b>F-4</b>	-----	Time constant 5 sec
<b>F-5</b>	-----	Time constant 10sec

### Analog Selection

Select "Analog Selection" with the **(MODE)** key. The message is **RnR** displayed for 1 sec. and then the pressure of analog output is displayed. Select ΔP, P1 or P2 with the ▲▼ keys.

### Analog Output Scaling

This mode is for setting the pressure for the analog output zero point and span point.

Display by analog selection is scaled as 0 to 100% (Zero point : 1Vdc or 4mA dc, Span : 5Vdc or 20mA dc). Select "Analog Scaling" with the **(MODE)** key. The message **R-L** is displayed for 1 sec. and the current pressure's analog output zero point (1Vdc) is displayed as a percentage. Change the numeric value with the ▲▼ keys.

The analog output span point's **R-H** pressure can be set in the same way using the **(MODE)** and ▲▼ keys.

Ex.) With Analog output of 1 to 5Vdc at pressure range of 0 to 100 psid (0 to 100%F.S.), output is changed to 1 to 5Vdc at 0 to 90 psid.

**R-H** Press. at time of analog output zero point: 0.0% F.S. → 0.0% F.S.  
(1Vdc output with pressure range 0% F.S.)

**R-L** Press. at time of analog output span point: 100.0% F.S. → 90% F.S.  
(5Vdc output with pressure range 90% F.S.)

## 10. Switch Setting Mode

### Setup

In Measurement Mode press the **(MODE)** key (release within 3 sec.) to change to Switch Setting Mode.

### Switch Setting Mode

There are two switches, OUT1 and OUT2. Both "Hysteresis (upper/lower limit)" and "Window Comparator" operations can be selected in the function setting mode (switch operation selection). Those two operations can be selected at once, and can be set. Both OUT1 and OUT2 can be set

independently to a max on/off delay of 2 seconds. In the following explanation, if the switch's output conditions are met their output state will become On, and "Switch LED (OUT1, OUT2)" will light up.

PLEASE NOTE that if the switch's setting value is set outside the display range, the switch's setting value can be rewritten automatically by the function setting mode operation.

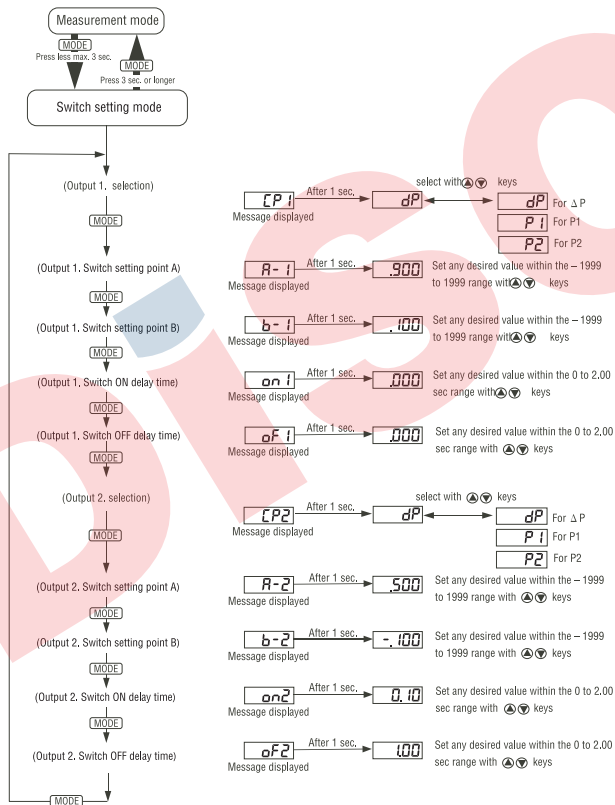



## 11. Switch Operation – Hysteresis/Deadband

### Setting the upper limit.

This is the mode in which the switch operates with the setting value (A) as the upper limit. The upper limit setting is determined when you select a positive number (including 0) for setting value (b).

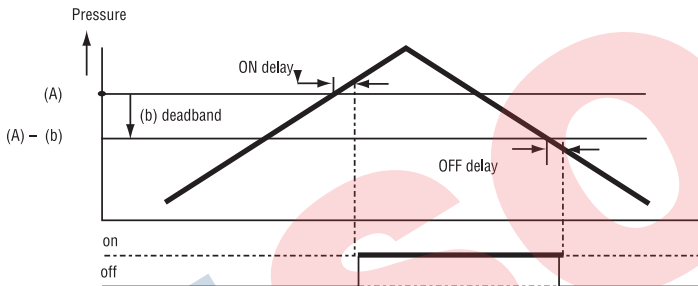

### Setting the lower limit.

This is the mode in which the switch operates with the setting value (A) as the lower limit. The lower limit setting is determined when you select a negative number for setting value (b).

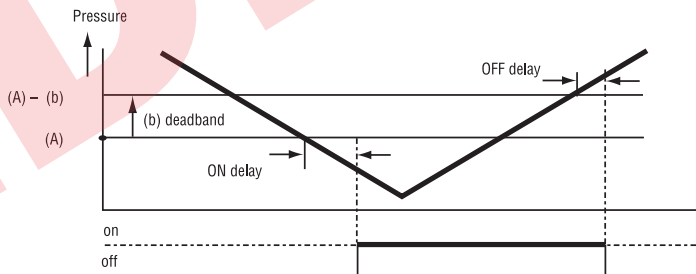

## Operation of Window Comparator

- For  $(A) \cong (b)$

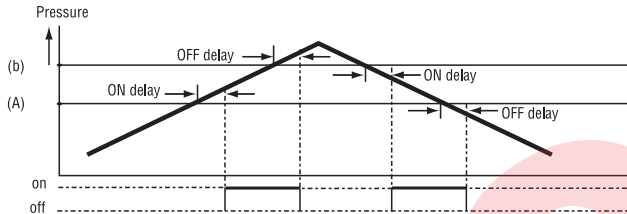

- For  $(A) > (b)$

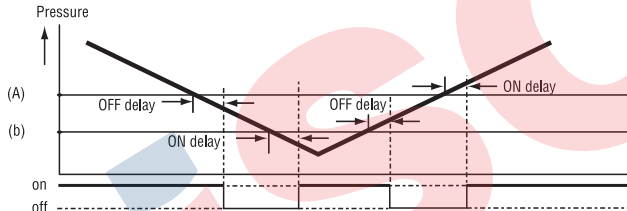

The 1% F.S. deadband is automatically set internally for setting point (A) and (b).

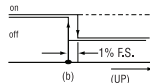
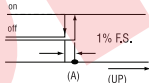

## 12. Loop Check Mode

### Setup Steps

In measurement mode press the **(MODE)** + **▲▼** keys (release within 3 sec.) to change to Loop Check Mode.

Regardless of applied pressure, display and analog output can be tested manually using the **▲▼** keys, useful for simulation testing of the analog output and switch output wiring. After the switch setting press **[LoP]** for 1 sec. to change into Loop Check Mode. The initial value will be the value displayed immediately before entering Loop check mode.

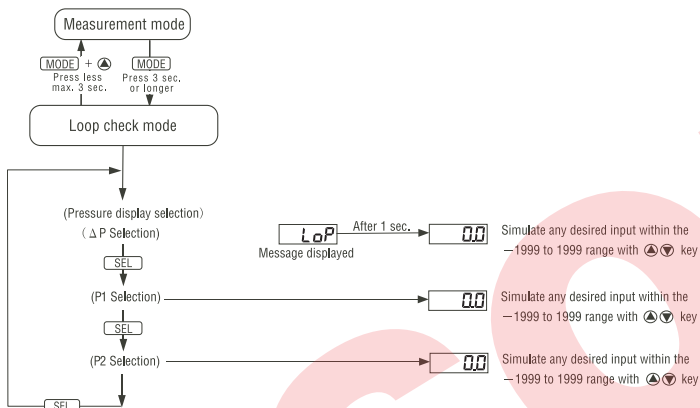

## 13. Other Functions

### Basic Key operations

In all setting modes, values are set with the ▲▼ keys. Use the ▲ key to increase and the ▼ key to decrease the value. A repeat state occurs in three phases of speed when the ▲▼ keys are pressed for more than 0.5 seconds to increase or decrease numerical value. ▲▼ keys are also used for setting switch, unit and filter in the function setting mode.

#### Adjusting the zero point of P1, P2

In measurement mode, select display to adjust zero using (SEL) key. Press (MODE) + ▲▼ keys for more than 3 seconds (until "----" display blinks) after releasing pressure from the pressure port. Auto-matic zero adjustment takes place approximately 1 second later for pressure display to be zero. When the zero adjustment is successful, (RdJ) is displayed.

Error (E-0) displays for 1 second when applied pressure was outside of range of -5 to 5% F.S., zero adjustment will not be allowed.

#### Adjusting the zero point of ΔP

Only when display scaling (EEL) is selected in display select on function setting mode, zero adjustment can be done. Press (MODE) + ▼ keys for more than 3 seconds (until "----" display blinks) after releasing pressure from the pressure ports. Automatic zero adjustment takes place approximately 1 second later.

---

When zero adjustment is successful, **[RdJ]** displays. When in -1999 to 1999 of display range, adjustment can be done.

On  $\Delta P$  display scaling of function mode **[EEI]**, zero adjustment value is reset and returns to initial value when each setting changes.

**[E-D]** displays for 1 second when  $\Delta P$  zero adjustment cannot be done.

### Maximum / Minimum Pressure Capture

The GC55 unit keeps the maximum and minimum pressure level applied to the pressure port as peak and bottom values respectively, in the internal memory. The peak and bottom values are displayed while holding the **▲** or **▼** keys respectively. Message **[PEP]** is displayed for one second and selected Max/Min value is displayed by this operation. Maximum and minimum values are reset when you reset power to the unit or by the following procedure:

Resetting Maximum value: While holding the **▲** key, press the **▼** key.

Resetting Minimum value: While holding the **▼** key, press the **▲** key.

### Key Lock

In measurement mode, press the **[MODE]** + **[SEL]** keys after the message **[LoI]** displays for 1 second, indicating that the unit has entered into the key lock state. All operations except Maximum / Minimum hold display and display selections cannot be accessed. The key lock mode cannot be reset by turning the power OFF and ON. It can be reset only by following the unlocking procedure.

Press the **[MODE]** + **[SEL]** keys, message **[UnL]** displays for 1 second and key lock is canceled.

## Error Display

An error message and a pressure are alternately displayed when one of the following errors occurs while in measurement mode.

Error Display	Definition	Definition
FFF	Pressure above 105% F.S. of sensor range is applied, or when indicated value exceeded 1999. (If pressure display is not selected, LED blinks.)	
-FFF	Pressure less than -5% F.S. of sensor range is applied, or when indicated value exceeded -1999. (If pressure display is not selected, LED blinks.)	Return pressure to within rated range.
E-0	Pressure outside of the range of $\pm 5\%$ F.S. is applied during zero adjustment of P1 and P2.	Open the unit to the atmosphere and adjust zero.
	Adjusting zero point when psi is selected on $\Delta P$ display selection.	Select <input type="checkbox"/> E-L <input type="checkbox"/> "this is what will show on your screen" on $\Delta P$ display selection and adjust zero point, When in "PSI" mode zero adjustments can be done on P1 and P2 respectively but not DP.

## Backup of Setting Values

The unit has an internal EEPROM to maintain settings and the key lock state for power interruption.

---

## 14. MAINTENANCE AND WARRANTY

### ■ **Periodic Inspection**

Depending upon the type of use periodic inspection is recommended at least once a year. Please refer to the following items for periodic inspection.

#### **(1) Appearance**

#### **(2) Display/output check via appropriate pressure standard<sup>(1)</sup>**

#### **(3) Display/output check via Loop Check<sup>(2)</sup>**

### ■ **CAUTION**

- Avoid electrostatic charging. When cleaning this product, please use a soft, damp, cloth.
- Do not use thinner, etc. which may cause deterioration and failure.

### ■ **Product warranty**

Except as otherwise provided, the product warranty of this product is as follows:

Period: 12 months after delivery

Warrantable defects: Defects resulting from the design and manufacture of our company, the quality of the material, etc.

Implementation of warranty: This warranty will be completed by substitution or repair of the product concerned.

We will not take responsibility for consequential damages caused by product defects.

- If you have any questions about this document, please contact the sales office or distributor nearest you.
- This document is subject to change without notice due to upgrade etc.

(1) If zero correction is required refer to section 13.

(2) Loop check, see section 12.

---

EDISON

---

EDISON

© 2007 Ashcroft Inc. 250 East Main Street, Stratford, CT 06614 USA  
Tel: 203-378-8281, Fax: 203-385-0402 [www.ashcroft.com](http://www.ashcroft.com)  
All sales subject to standard terms and conditions of sale.  
I&M011-10158 - 12/09